

ATV WINDSHIELD

PART #1
Plastic Collars



PART #2
Handlebar Brackets



PART #3
Long Bolts



PART #4
Support Connectors



PART #5
Support Arms



PART #6
2 M Allen bolts
2 S Allen bolts



PART #7
Windshield Brackets



PART #8
Windshield



PART #9
Windshield Bolts



PART #10
Washers



PART #11
Rubber Washers



PART #12
Wing Nuts



*For ease of installation and windshield placement, leave all hardware loose until final position of windshield is achieved.

#1 Install plastic collars [Part #1] on handle bars where the handle brackets [Part #2] will be located.

PART #1
Plastic Collars

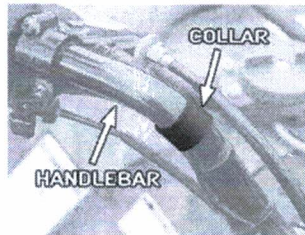

#2 Install handle bar brackets [Part #2] over the plastic collars [Part #1] on the handlebars.

PART #2
Handlebar Brackets

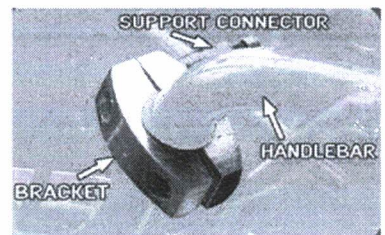
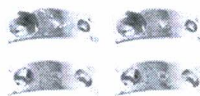

#3 Use the long bolt [Part #3] & Short S bolt [Part #6] to go through handlebar brackets [Part #2] and thread into support connector [Part #4]

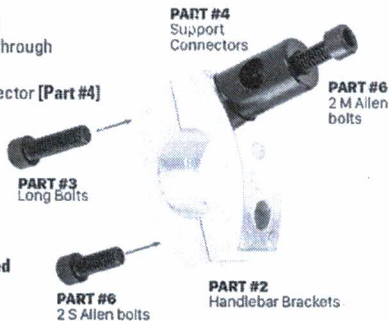

*Make sure support connector [Part #4] is seated in the recessed hole of the handlebar clamp [Part #2]

#4 Install windshield support arms [Part #5] into each support connector [Part #4] and thread in medium bolt [Part #6] into support connector [Part #4]

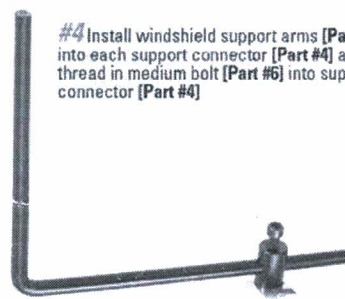

PART #5
Support Arms



PART #4
Support Connectors



PART #6
2 M Allen bolts



#5 Install two windshield brackets [Part #7] on each support arm [Part #5]

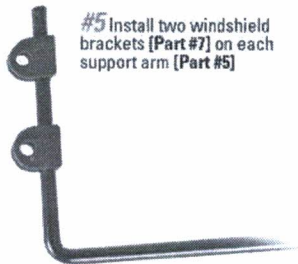

PART #5
Support Arms



PART #7
Windshield Brackets



#6 Install the windshield [Part #8] to the support arms [Part #5] with metal washer [Part #10] and rubber washer [Part #11] through windshield [Part #8] and windshield bracket [Part #7] Secure with metal washer [Part #10] and wing nut [Part #12]

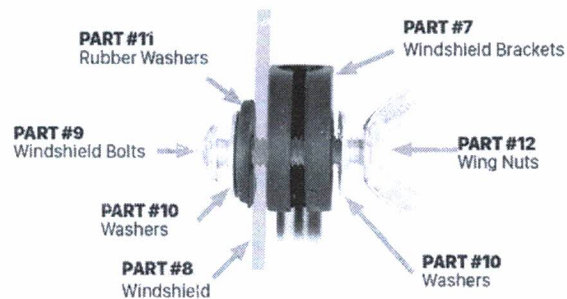

#7 To achieve desired location of windshield, adjustment of support arms [Part #5] and brackets [Part #2] is regained.

*Note this is a universal windshield kit and may take several adjustments to position properly on your ATV.

PART #2
Handlebar Brackets

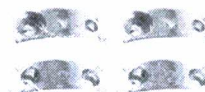

PART #5
Support Arms

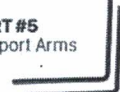

#8 Tighten all hardware at this point, paying attention not to over tighten

*Note before driving ATV operate all levers, throttle and handle bars to insure proper operation with no interference of windshield.